



THINKWELL HARDWARE & MACHINERY

Marine Hardware

Thinkwell

CONTENT

(02) • Introduction

01 • Type A Folding Anchor

01 • Type B Folding Anchor

01 • Type C Folding Anchor (I)

02 • Type C Folding Anchor (II)

02 • Danforth Anchor

02 • Plate Anchors

03 • Type B Plate Anchors

03 • Bruce Anchor

04 • Plough Anchor

04 • Stock Anchor

04 • Mushroom Anchor

05 • Hall Anchor

06 • Dock Cleat(GM005-92A)

07 • Dock Cleat(GM006-92B)

07 • Single Cross Bollard

07 • Double Cross Bollard

08 • Rowlock Horn

08 • Boat Rowlock with Mount

08 • Boat Rowlock



COMPANY PROFILE

Thinkwell is ISO certified professional manufacturer in Marine Hardware over 15 years. We have 4 advanced production line, 160 staff and more than 1500 square warehouse. Design-Production-Packing-Shipping, our One-Stop service saves customers lots of time, cost and energy. From normal to upgraded customized parts, Thinkwell Marine Hardware enjoying good sales in ruling market. We have established WIN-WIN relationship with some of world famous Marine Hardware brand from North America and Australia many years. Welcome more and more customers from all over the world.



Thinkwell CERTIFICATE

- Over 15 years producing experience in Hardware&Steel Parts
- Professional Design Team to develop and design new parts according to customers' requirements
- Professional Quality Control Team and advanced Testing Machine to insure the quality
- Professional Sales Team to give inquiry feedback in the first time.
- Customized Parts, Customized Logo and Customized Packing available
- 12 months Quality Guarantee.



Marine Hardware

1. Type A Folding Anchor

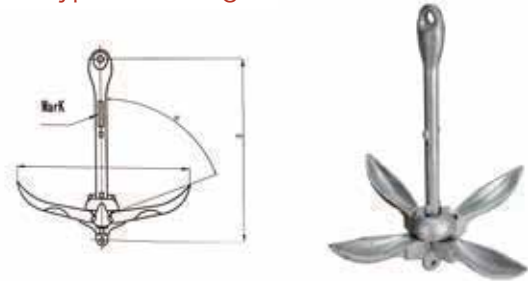

Part No.	Weight (kg)	Dimensions(mm)		
		H	Length	α
TKM0001	1.5	278	290	75±5°
TKM0002	2.5	334	320	
TKM0003	3.2	370	360	
TKM0004	4	422	400	
TKM0005	6	500	465	
TKM0006	8	536	535	

2. Type B Folding Anchor

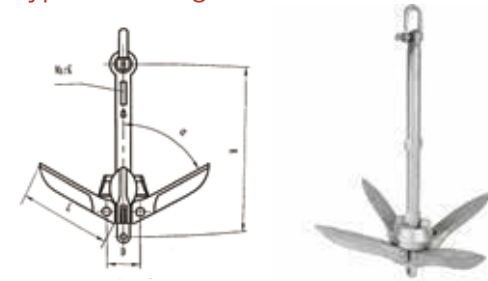

Part No.	Weight (kg)	Anchor Shackle	Dimensions(mm)			
			H	L	D	α
TKM0007	0.74	M5	158	70	36	65±5°
TKM0008	1.4	M6	285	134.5	42	65±5°
TKM0009	2.3	M8	307	181	43	65±5°
TKM0010	3.5	M8	380	206	48	65±5°
TKM0011	5.5	M10	443	233	56	65±5°
TKM0012	7.5	M10	513	250	70	65±5°
TKM0013	10	M12	619	290	75	75±5°
TKM0014	12	M12	663	310	76	75±5°
TKM0015	15	M12	630	340	80	65±5°

3. Type C Folding Anchor (I)

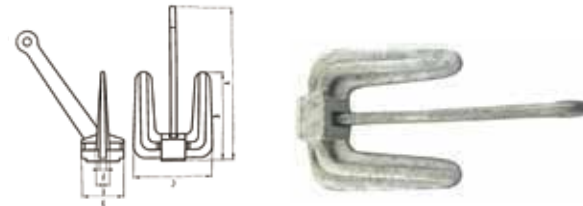

Part No.	Weight (kg)	Dimensions(mm)					
		A	B	C	D	E	F
TKM0016	1.7	257	150	134	69	23	12
TKM0017	2.1	290	156	137	71	23	13
TKM0018	2.5	310	178	160	71	24	10
TKM0019	2.8	310	175	160	78	26	15
TKM0020	3.7	340	197	172	84	28	15
TKM0021	4	340	197	196	87	28	15
TKM0022	5	395	220	205	90	27	17
TKM0023	6	395	235	208	92	36	21
TKM0024	6.3	395	235	205	90	36	21
TKM0025	8	505	280	232	102	35	18
TKM0026	9.1	500	290	246	106	33	21
TKM0027	10	500	290	242	105	35	13
TKM0028	12	510	300	265	110	40	26
TKM0029	15	610	320	280	110	42	28
TKM0030	20	640	350	310	122	44	30
TKM0031	30	760	420	365	140	50	34

4. Type C Folding Anchor (II)

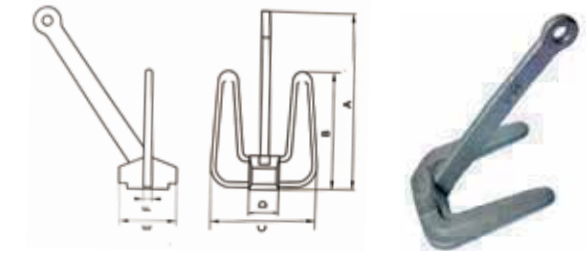

Part No.	Weight (kg)	Dimensions(mm)					
		A	B	C	D	E	F
TKM0032	2	287	160	138	45	80	26
TKM0033	3	310	176	162	46	86	29
TKM0034	4	330	201	188	50	88	36
TKM0035	6	391	235	210	54	94	42
TKM0036	8	495	267	232	60	98	42
TKM0037	10	495	285	243	62	108	48

5. Danforth Anchor

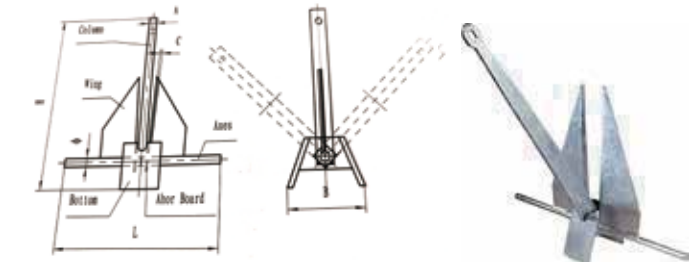

Part No.	Weight (kg)	Dimensions(mm)					
		A	B	C	H	L	ϕ
TKM0038	3	12	130	4	450	400	14
TKM0039	5	12	156	4	605	430	18
TKM0040	7.5	16	180	4	665	470	18
TKM0041	10	16	200	6	700	540	18

6. Plate Anchors

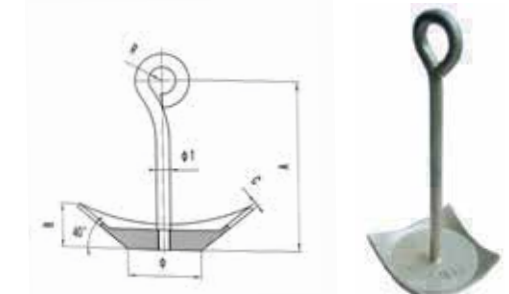

Part No.	Weight (kg)	Plate Measure (mm)	Dimensions(mm)					
			A	B	C	ϕ	$\phi 1$	R
TKM0042	3	160*160*5	350	44	5	93	16	20
TKM0043	5	210*210*6	390	61	6	112	18	20
TKM0044	8	240*240*7	445	72	7	121	22	25
TKM0045	10	250*250*8	470	77	8	130	25	25

Marine Hardware

7. Type B Plate Anchors



Part No.	Weight (kg)	Dimensions(mm)				
		A	B	C	D	E
TKM0046	3	320	180	16	36	85
TKM0047	5	350	200	18	38	90
TKM0048	8	445	225	25	48	105
TKM0049	10	445	250	25	48	120
TKM0050	12	475	285	25	50	130

8. Bruce Anchor

Carbon steel & Stainless steel

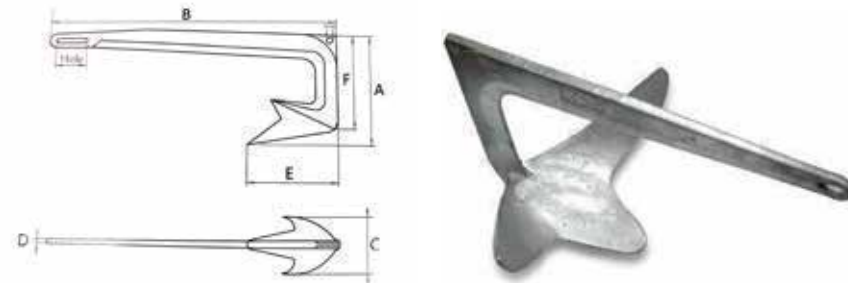

Part No.	Weight (kg)	Dimensions(mm)							
		A	B	C	D	E	F	Hole	Hole
TKM0051	1	176	295	142	7	90	110	19*8	φ7
TKM0052	2	215	340	195	10	95	130	22*11	φ7
TKM0053	5	280	485	298	12	165	198	25*13	φ9
TKM0054	7.5	318	518	340	13	180	205	28*13	φ11
TKM0055	10	340	580	358	16	190	250	19*13	φ12
TKM0056	15	380	615	400	16	230	240	30*15	φ10
TKM0057	20	410	642	460	22	255	270	38*18	φ15
TKM0058	30	460	810	535	22	275	290	42*20	φ13
TKM0059	50	575	860	710	30	320	385	50*22	φ18

9. Plough Anchor



Part No.	Weight (kg)	Dimensions(mm)						
		A	B	C	D	E	F	Hole
TKM0060	5	440	200	220	55	20	22	φ16
TKM0061	7	450	220	240	60	21	25	φ16
TKM0062	9	510	260	260	60	26	25	φ21
TKM0063	12	580	300	300	62	27	26	φ21
TKM0064	15	670	310	320	70	28	30	φ21
TKM0065	16	700	312	320	70	28	30	φ21
TKM0066	22	750	320	360	80	30	34	φ21
TKM0067	27	770	350	380	80	30	35	φ21

10. Stock Anchor

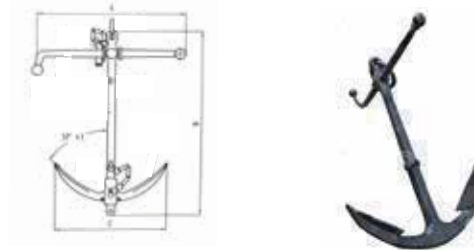

Part No.	Weight (kg)	Dimensions(mm)		
		A	B	C
TKM0068	5	450	565	335
TKM0069	7	450	625	400
TKM0070	10	550	655	500
TKM0071	12	550	750	515
TKM0072	15	625	760	565
TKM0073	20	725	795	580
TKM0074	25	800	820	650
TKM0075	35	790	920	835

11. Mushroom Anchor

Part No.	Weight (lbs.)
TKM0076	8
TKM0077	10
TKM0078	15
TKM0079	20



Miscellaneous Hardware

12. Hall Anchor



Part No.	Weight (kg)	Dimensions(mm)							
		A	B	C	H	H1	L	L1	B1
TKM0080	40	557	557	430	303	67	430	303	198
TKM0081	60	637	637	492	347	76	492	347	227
TKM0082	100	760	760	590	410	90	584	410	270
TKM0083	125	814	814	629	443	97	629	443	290
TKM0084	150	866	866	665	470	103	670	470	308
TKM0085	180	919	919	710	500	110	710	500	327
TKM0086	240	1019	1019	788	552	121	784	552	361
TKM0087	300	1095	1095	850	595	130	844	595	388
TKM0088	360	1160	1160	898	630	138	898	630	412
TKM0089	420	1222	1222	946	660	145	946	660	434
TKM0090	180	1282	1282	986	690	152	988	690	454
TKM0091	570	1356	1356	1042	732	161	1042	732	481
TKM0092	660	1422	1422	1093	769	169	1096	769	506
TKM0093	780	1506	1506	1159	813	178	1160	813	535
TKM0094	900	1580	1580	1215	855	188	1220	855	560
TKM0095	1020	1645	1645	1268	891	195	1268	891	584
TKM0096	1140	1705	1705	1316	926	203	1319	926	605
TKM0097	1290	1778	1778	1378	965	211	1374	965	630
TKM0098	1440	1844	1844	1448	1001	219	1430	1001	655
TKM0099	1590	1906	1906	1511	1035	226	1475	1035	677
TKM0100	1740	1966	1966	1571	1068	234	1517	1068	698
TKM0101	1920	2031	2031	1602	1104	241	1568	1104	722
TKM0102	2100	2093	2093	1651	1136	249	1614	1136	743
TKM0103	2280	2150	2150	1716	1165	255	1657	1165	763
TKM0104	2460	2207	2207	1785	1194	262	1700	1194	784
TKM0105	2640	2259	2259	1843	1221	268	1741	1221	801
TKM0106	2850	2318	2318	1890	1253	275	1787	1253	822
TKM0107	3060	2374	2374	1935	1283	282	1832	12383	841
TKM0108	3300	2432	2432	1985	1317	288	1880	1317	862
TKM0109	3540	2490	2490	2032	1349	295	1926	1349	883
TKM0110	3780	2547	2547	2077	1376	302	1965	1376	902
TKM0111	4050	2610	2610	2125	1406	309	2008	1406	924
TKM0112	4320	2661	2661	2171	1435	316	2051	1435	943
TKM0113	4590	2712	2712	2216	1465	322	2093	1465	962
TKM0114	4890	2769	2769	2263	1498	329	2135	1498	984
TKM0115	5250	2836	2836	2317	1535	337	2185	1535	1008
TKM0116	5610	2899	2899	2369	1569	345	2234	1569	1031
TKM0117	6000	2965	2965	2422	1605	352	2284	1605	1054
TKM0118	6450	3037	—	2482	1644	361	2340	1644	1080
TKM0119	6900	3100	—	2538	1681	369	2393	1681	1105
TKM0120	7350	3173	—	2592	1717	377	2444	1717	1129

TKM0121	7800	3235	—	2644	1752	385	2493	1752	1125
TKM0122	8300	3363	—	2699	1788	393	2545	1788	1176
TKM0123	8700	3355	—	2742	1816	399	2585	1816	1195
TKM0124	9300	3430	—	2804	1857	408	2643	1857	1222
TKM0125	9900	3502	—	2863	1896	417	2699	1896	1248
TKM0126	10500	3571	—	2920	1934	425	2752	1934	1273
TKM0127	11100	3638	—	2975	1970	433	2803	1970	1297
TKM0128	11700	3702	—	3028	2005	441	2853	2005	1320
TKM0129	12300	3764	—	3079	2039	448	2901	2039	1342
TKM0130	12900	3824	—	3128	2072	455	2947	2072	1363
TKM0131	13500	3882	—	3176	2104	462	2992	2104	1384
TKM0132	14100	3939	—	3222	2135	469	3036	2135	1404
TKM0133	14700	3994	—	3267	2165	476	3078	2165	1424
TKM0134	15400	4056	—	3318	2199	483	3126	2199	1446
TKM0135	16100	4117	—	3368	2232	490	3173	2232	1468
TKM0136	16900	4184	—	3423	2268	498	3225	2268	1492
TKM0137	17800	4252	—	3479	2308	506	3281	2308	1518
TKM0138	18800	4330	—	3543	2350	516	3341	2350	1546
TKM0139	20000	4420	—	3617	2399	526	3411	2399	1578
TKM0140	21500	4528	—	3705	2458	539	3494	2458	1617
TKM0141	23000	4631	—	3789	2514	551	3573	2514	1654
TKM0142	24500	4730	—	3870	2568	563	3649	2568	1689
TKM0143	26000	4825	—	3947	2619	574	3722	2619	1723
TKM0144	27500	4916	—	4021	2668	585	3792	2668	1756
TKM0145	29000	5004	—	4093	2716	595	3860	2716	1787
TKM0146	31000	5126	—	4188	2774	609	3949	2774	1822
TKM0147	33000	5234	—	4276	2833	622	4032	2833	1860
TKM0148	35500	5363	—	4381	2903	637	4132	2903	1906
TKM0149	38500	5510	—	4502	2982	655	4245	2982	1958
TKM0150	42000	5672	—	4634	3070	674	4370	3080	2015
TKM0151	46000	5847	—	4777	3165	695	4505	3165	2078

13. Dock Cleat(GM005-92A)

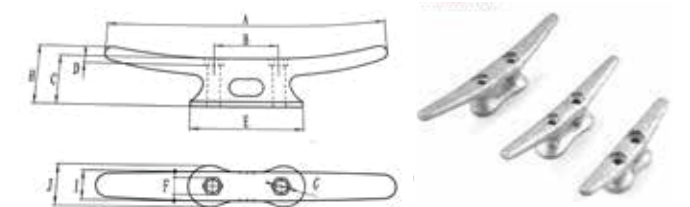

Part No.	Size(in.)	Dimensions(mm)										
		A	B	C	D	E	F	G	H	I	J	B
TKM0152	3.5	89	21	20	2.5	42	10	5.5	25	12	17.5	1/8
TKM0153	4	104	23	22	4.5	47	11	6.5	28.5	15	22	3/16
TKM0154	5	126	27.5	27	4.5	56	11	6.5	34.5	15.5	22.5	3/16
TKM0155	6	146	31.7	28	4.76	55	11.98	8.4	34	18	22	1/4
TKM0156	8	201	41.4	40	5.84	81	13.63	10	51	25	35	5/16
TKM0157	8	203	41.4	39	7.1	74	15.3	11.6	48	24	31	3/8
TKM0158	10	263	60.5	49	7.06	103.5	15.23	11.55	59	27	38	3/8
TKM0159	12	306	85.8	59	7.06	141	15.23	12	74	30	48	3/8
TKM0160	14	361	107.9	69	9.13	156	21	15.08	90	33	49	1/2
TKM0161	18	456	136.7	88	12	230	26.5	18.01	120	49	66	5/8
TKM0162	24	608	160	124	18	333	35	25	148	57	111	7/8

Marine Hardware

14. Dock Cleat(GM006-92B)

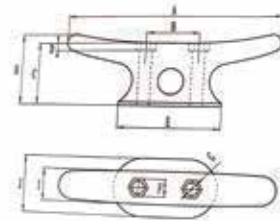

Part No.	Size(in.)	Dimensions(mm)										
		A	B	C	D	E	F	G	H	I	J	B
TKM0163	8	220	50.8	59	9.13	102	20.05	15.08	69	32.5	58	1/2
TKM0164	10	253	61.9	73	9.09	120	20.05	14.52	86	38	67	1/2
TKM0165	12	302	85.8	82	11.53	175	24.73	18	94	48.5	76	5/8
TKM0166	15	384	90.15	95	11.91	180	30.5	21	114	53	85	3/4
TKM0167	18	460	98.4	112	11.91	191	30.5	21	130.5	56.5	109	3/4
TKM0168	24	620	152	182	40	330	φ62	30	197	105	118	7/8

15. Single Cross Bollard

Carbon steel & Stainless steel

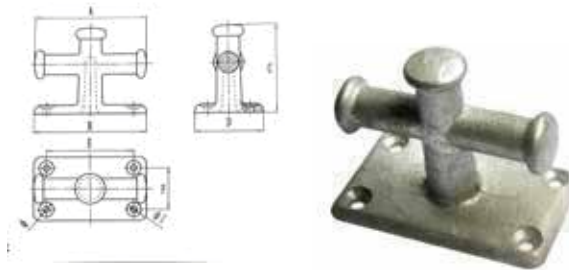

Part No.	Dimensions(mm)						
	A	B	C	D	E	φ	φ1
TKM0169	110	110	88	60	40	7	14
TKM0170	140	140	110	80	52	8.5	18

16. Double Cross Bollard

Carbon steel & Stainless steel

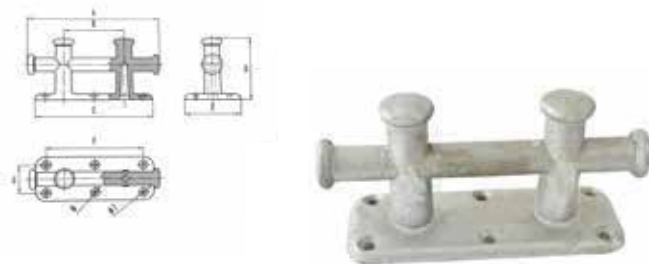

Part No.	Dimensions(mm)								
	A	B	C	D	E	F	G	φ	φ1
TKM0171	198	94	180	101	70	144	40	8	18
TKM0172	264	122	235	127	90	194	57	8	18

17. Rowlock Horn

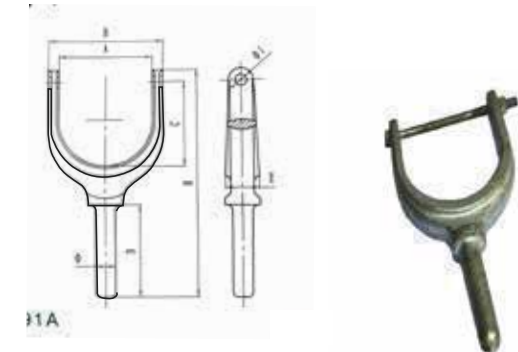

Part No.	Dimensions(mm)							
	A	B	C	D	E	H	φ	φ1
TKM0173	57	70	52.5	57	20	141	12	7
TKM0174	71	83	67.5	57	21	161	14	6.5

18. Boat Rowlock with Mount

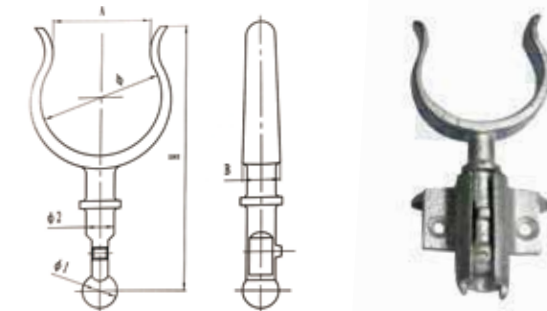

Part No.	Dimensions(mm)					
	A	B	H	φ	φ1	φ2
TKM0175	50	19	141	62	18	14.5
TKM0176	57	20	146	69	18	14.5
TKM0177	64	21.5	162.5	77	19	15
TKM0178	78	21	170.5	81	19	15

19. Boat Rowlock

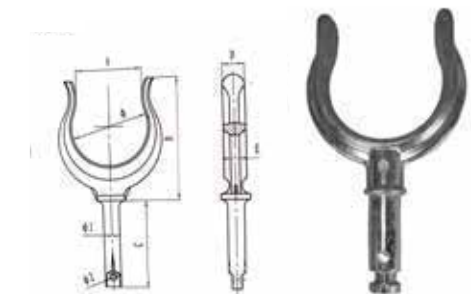

Part No.	Dimensions(mm)						
	A	B	C	D	φ	φ1	φ2
TKM0179	50	90	65	15	58	12	5
TKM0180	58	103.5	91.5	22	66	14	5
TKM0181	64	108	92	22	77	14	5
TKM0182	70	112	92	22	83	14	5
TKM0183	76	116	92	22	89	16	5



COMPANY PROFILE

Thinkwell is ISO certified professional manufacturer in Marine Hardware over 15 years. We have 4 advanced production line, 160 staff and more than 1500 square warehouse. Design-Production-Packing-Shipping, our One-Stop service saves customers lots of time, cost and energy. From normal to upgraded customized parts, Thinkwell Marine Hardware enjoying good sales in ruling market. We have established WIN-WIN relationship with some of world famous Marine Hardware brand from North America and Australia many years. Welcome more and more customers from all over the world.



Thinkwell CERTIFICATE

- Over 15 years producing experience in Hardware&Steel Parts
- Professional Design Team to develop and design new parts according to customers' requirements
- Professional Quality Control Team and advanced Testing Machine to insure the quality
- Professional Sales Team to give inquiry feedback in the first time.
- Customized Parts, Customized Logo and Customized Packing available
- 12 months Quality Guarantee.

